

平形250単極用REC

REC FOR FLAT TERMINAL 250 SINGLE-POLE

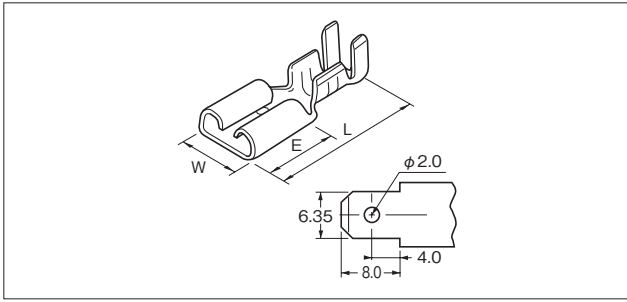

品番 Part No.	電線サイズ Wire Size		材質 Material	板厚 Thickness	L	W	E	個数/リール PCS/Reel	アプリケーション Applicator	備考 Reference
	AWG	断面積(mm ²) Sectional area(mm ²)								
225022-0	#14~#20	0.5~2.0	黄銅 Brass	0.32	19.4	7.5	7.75	5,000×3R	MCE-500	適合TAB厚0.8 (Mating TAB)

平形250単極用窓付REC

REC WITH WINDOW FOR TERMINAL 250 SINGLE-POLE

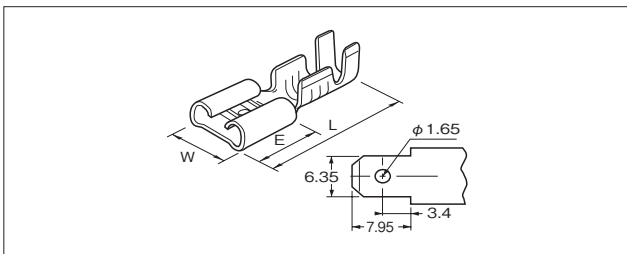

品番 Part No.	電線サイズ Wire Size		材質 Material	板厚 Thickness	L	W	E	個数/リール PCS/Reel	アプリケーション Applicator	備考 Reference
	AWG	断面積(mm ²) Sectional area(mm ²)								
225032-2	#14~#20	0.5~2.0	黄銅 Brass	0.43	19.3	7.6	7.8	4,000×3R	MCE-1500	適合TAB厚0.8 (Mating TAB)
225432-2	#18~#22	0.3~0.75	黄銅 Brass	0.43	19.3	7.6	7.8	6,000×3R	MCE-1500-A	適合TAB厚0.8 (Mating TAB)

注) 表面処理については「表面処理分類表(P236)」を参照ください。

Notice) Finishing code is available to see attached "Finishing Classification(P236)"